

GelWrap™ Installation Instructions

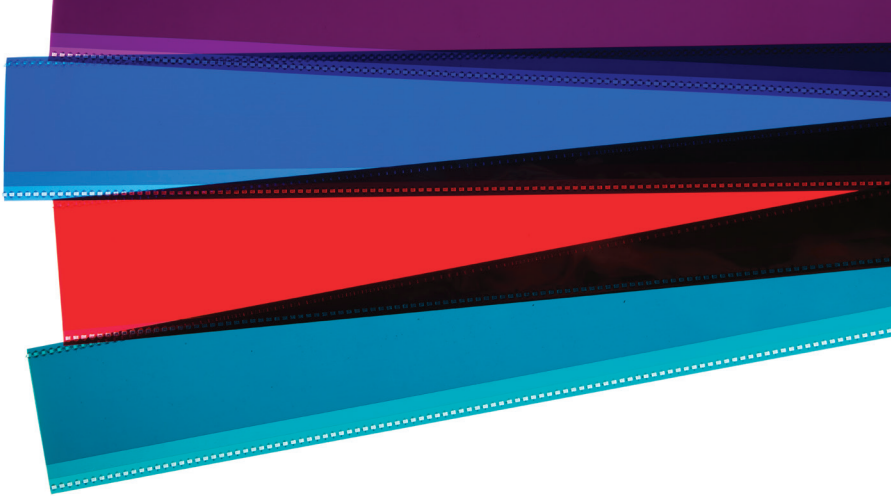

GelWrap™ T12 (with locking flap)

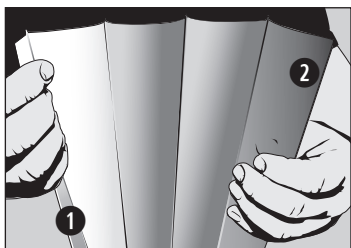

Step 1: Unfold the GelWrap™. There are five panels, four of similar width and one narrow locking tab ❶.

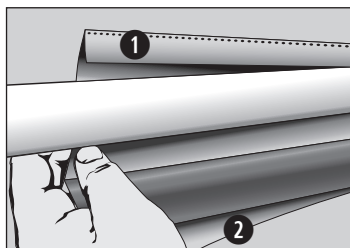

Step 2: Leave fluorescent tubes in fixture. Slide the GelWrap™ under the fluorescent tube with the narrow locking tab leading. Continue sliding the GelWrap™ around the tube until the narrow locking tab emerges over the top of the tube. Wrap the ❷ panel around the tube and under narrow locking tab ❶.

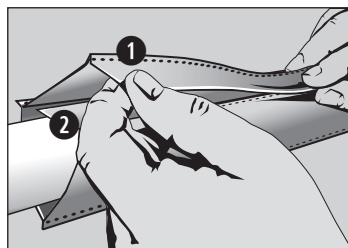

Step 3: Pinch corner of locking tab ❶. Slide your thumb under the length of the narrow locking tab making sure narrow locking tab ❶ overlaps underneath panel ❷.

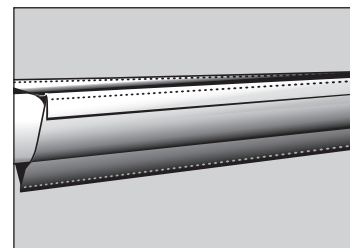

Step 4: Rotate the installed GelWrap™ so the double panel is on the top of the fluorescent tube.

GelWrap™ T5 or GelWrap™ T8 (without locking flap)

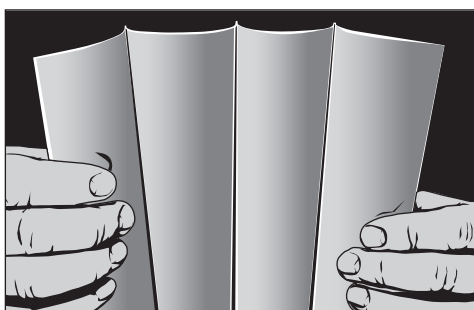

Step 1: Unfold the GelWrap™. There are four panels of similar width.

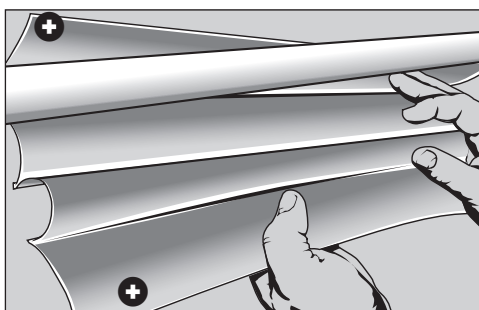

Step 2: Leave fluorescent tubes in fixture. Slide the GelWrap™ under the fluorescent tube until the panels + overlap.

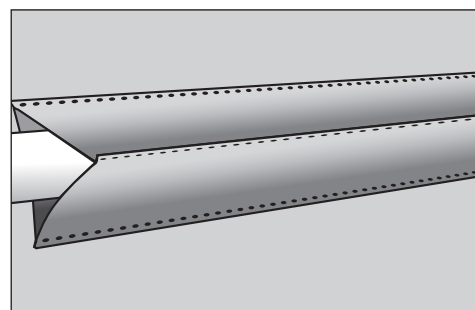

Step 3: Rotate the installed GelWrap™ so the double panel is on the top of the fluorescent tube.

Tube	Size
T5	½" x 48" (12.7mm x 1.219m)
T8	1" x 48" (25.4mm x 1.219m)
T12	1½" x 48" (38.1mm x 1.219m)



Apollo Design Technology, Inc.
260.497.9191 • ApolloDesign.net
7/17